

YAK SHELF

INSTRUCTION MANUAL

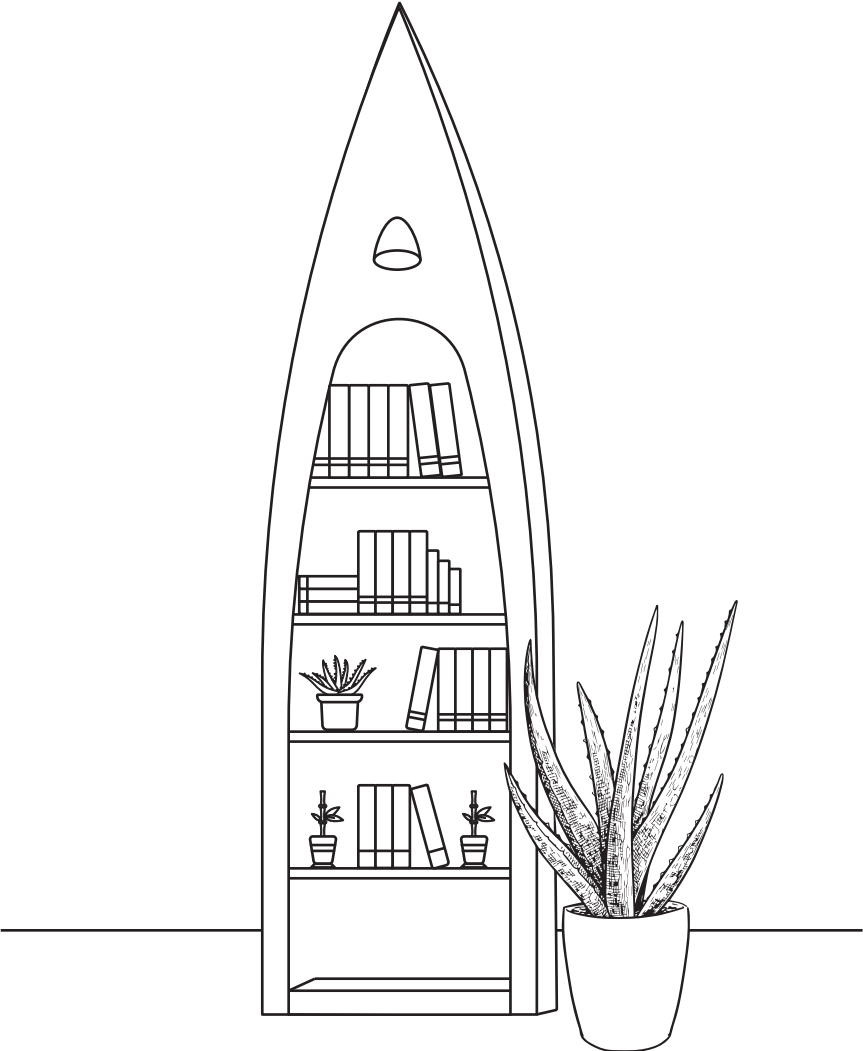

YAK SHELF

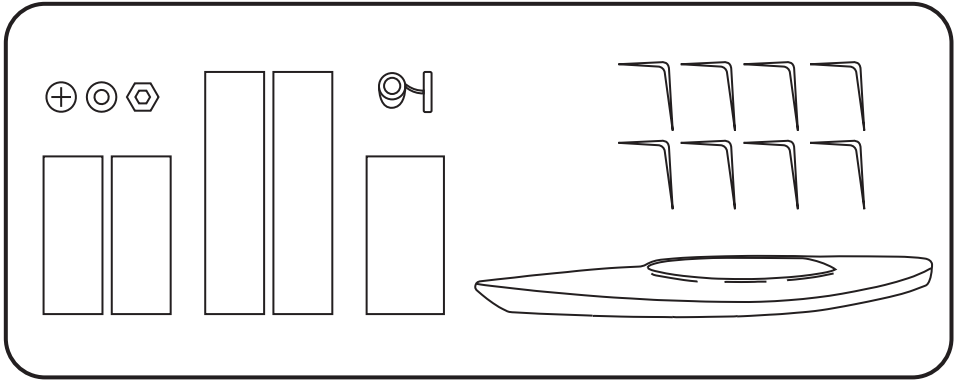

- 1.** Cut the back of your Yakoff, right behind the seat.

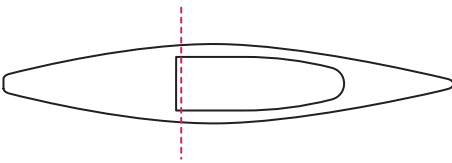

- 2.** Place the Yakoff onto a wooden plank. Trace the edges of the kayak onto the plank.

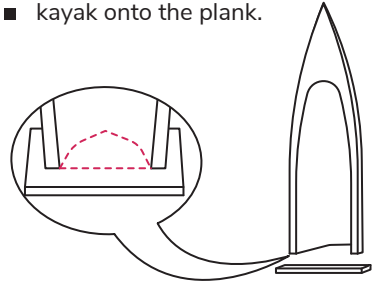

- 3.** Cut along the traced line to create your Yakshelf base.



- 4.** Measure out where you want your shelves. Install shelf brackets.

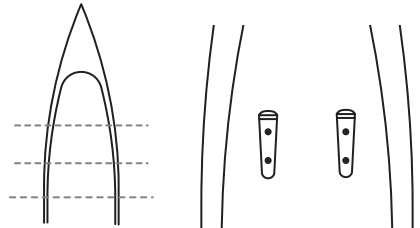

- 5.** Measure and cut your wood 2x4s to the correct size, insert, and secure them using screws.

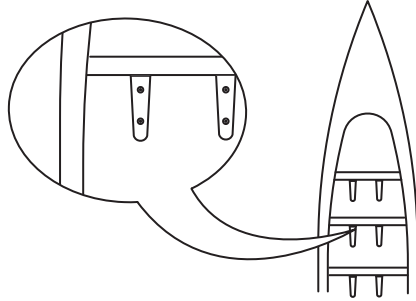

TIP #1
Make sure those bad boys are level before ya screw 'em.

- 6.** Bore a hole at the top of your Yakoff. This is where the light will go.

TIP #2
Don't make that hole huge. Huge holes won't work.



- 7.** Make sure your electrical chord has a direct line to an outlet. Then mount your lamp.

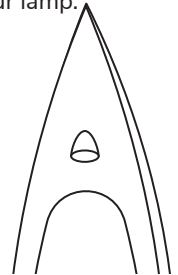

- 8.** That's it! You've turned your Yakoff into a magnificent looking Yakshelf. That you can put stuff in. Like books or taxidermy.

