

# THE LOVE YAK

INSTRUCTION MANUAL

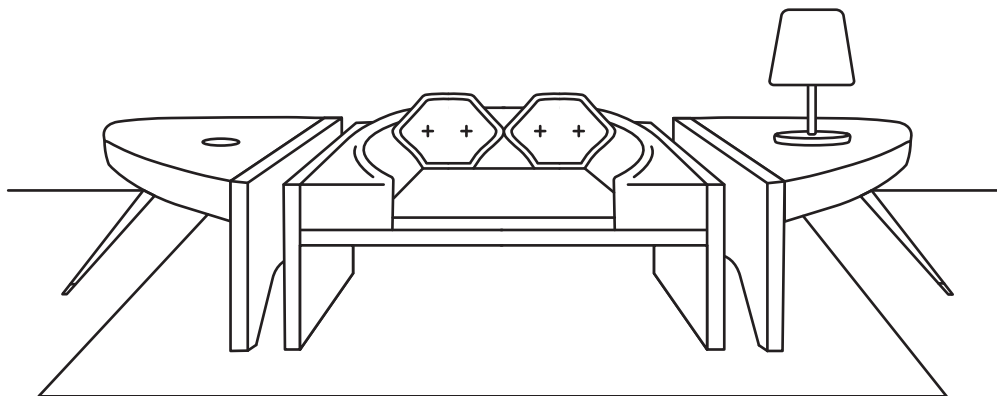

# THE LOVE YAK

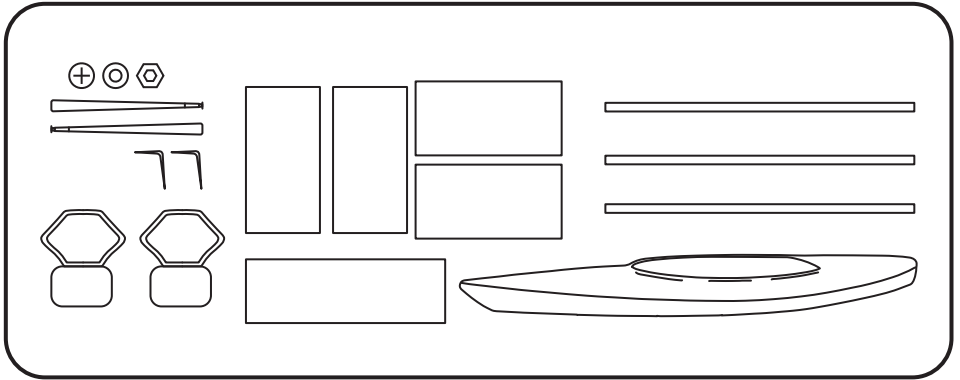

- 1.** First saw the sides off of your flimsy Yakoff. This part's easy.

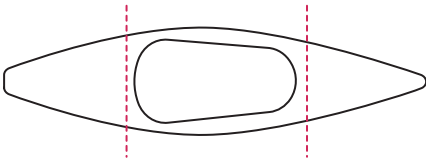

**TIP #1**  
Don't toss those sides.  
You'll need them later.

- 2.** Reinforce your Loveyak by tracing and cutting wood to fit snugly within the two openings.

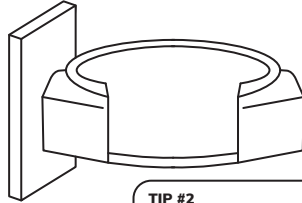

**TIP #2**  
Don't forget to trace both sides.  
Yakoffs are all sorts of uneven.

- 3.** Secure the wood placed in the openings using screws.

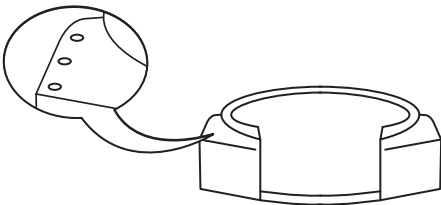

- 4.** For your Loveyak's legs, place the two additional planks on each side of your Yakoff. Trace the top edge and cut along that line.

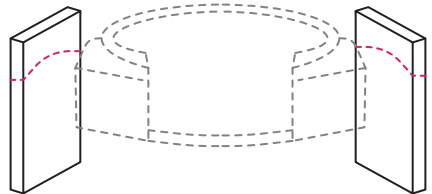

- 5.** Now screw your legs into both sides using six screws each.

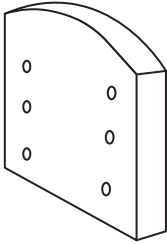

- 6.** Cut the foam to fit the interior of your kayak. Place it in and put your seat cushions on top.

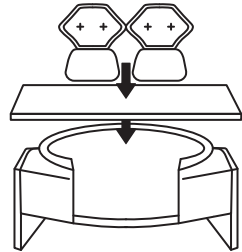

- 7.** Drill holes in the pieces of Yakoff you cut earlier. Screw and secure the leg with a washer and nut.

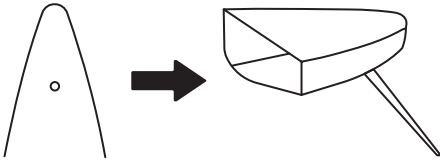

- 8.** Take piece of wood, trace the edges, then cut. Bolt the wood to the cut side of the Yakoff.

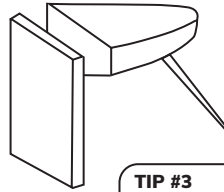

**TIP #3**

Repeat for another side Yaktable.  
Then put a lamp on there or something.

- 9.** Sit and relish in the fact that you're a DIY master.

